

VARYCONTROL® VAV Controller

Type TVR-Easy

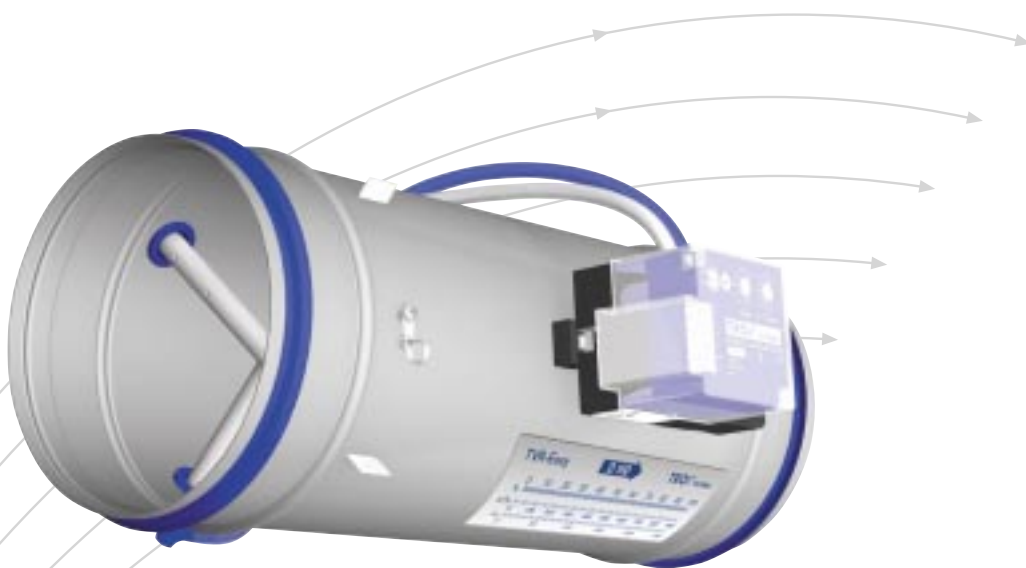

TROX® TECHNİK

TROX GmbH
Heinrich-Trox-Platz
D-47504 Neukirchen-Vluyn

Telephone +49/28 45/2 02-0
Telefax +49/28 45/2 02-2 65
e-mail trox@trox.de
www.troxtechnik.com

Contents

Innovation _____	3	Air-regenerated noise _____	8
Construction · Dimensions _____	4	Case-radiated noise _____	9
Technical data · Nomenclature _____	5	Flow rate adjustment _____	10
Selection of nominal size _____	6	Characteristics · Wiring examples _____	11
Acoustic quick selection _____	7	Order details _____	12

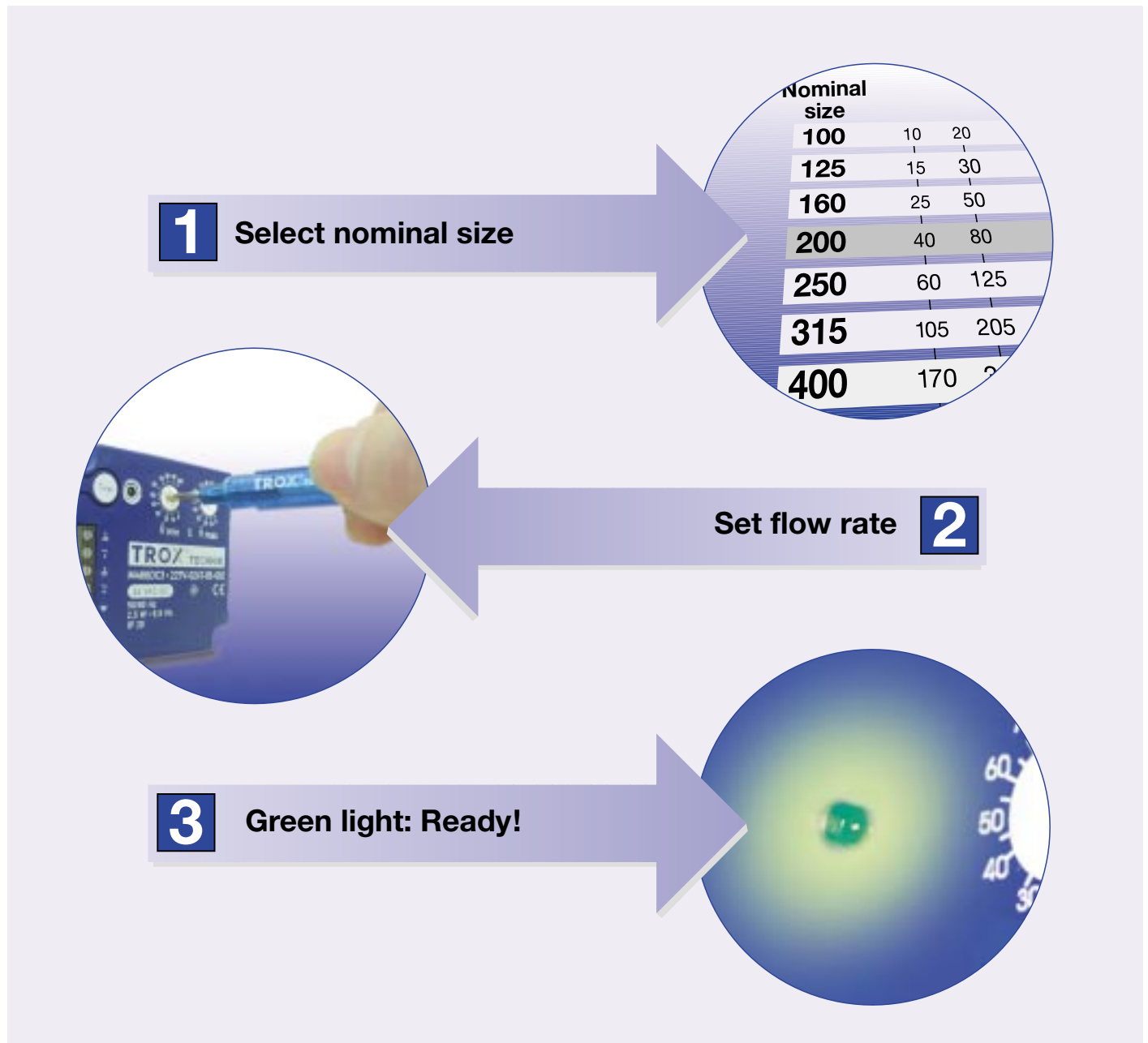

TROX TVR-Easy – the innovative solution

- **Easy** Selection according to nominal size of the duct system
- **Easy** Flow rate adjustment without adjustment tool
- **Easy** Functional testing with service button
- **Easy** Functional check by indicator light

The proven technology of the compact flow rate controller has been optimized. Valuable on site time saved by simple set up.

TVR-Easy, developed with consultants and customers!

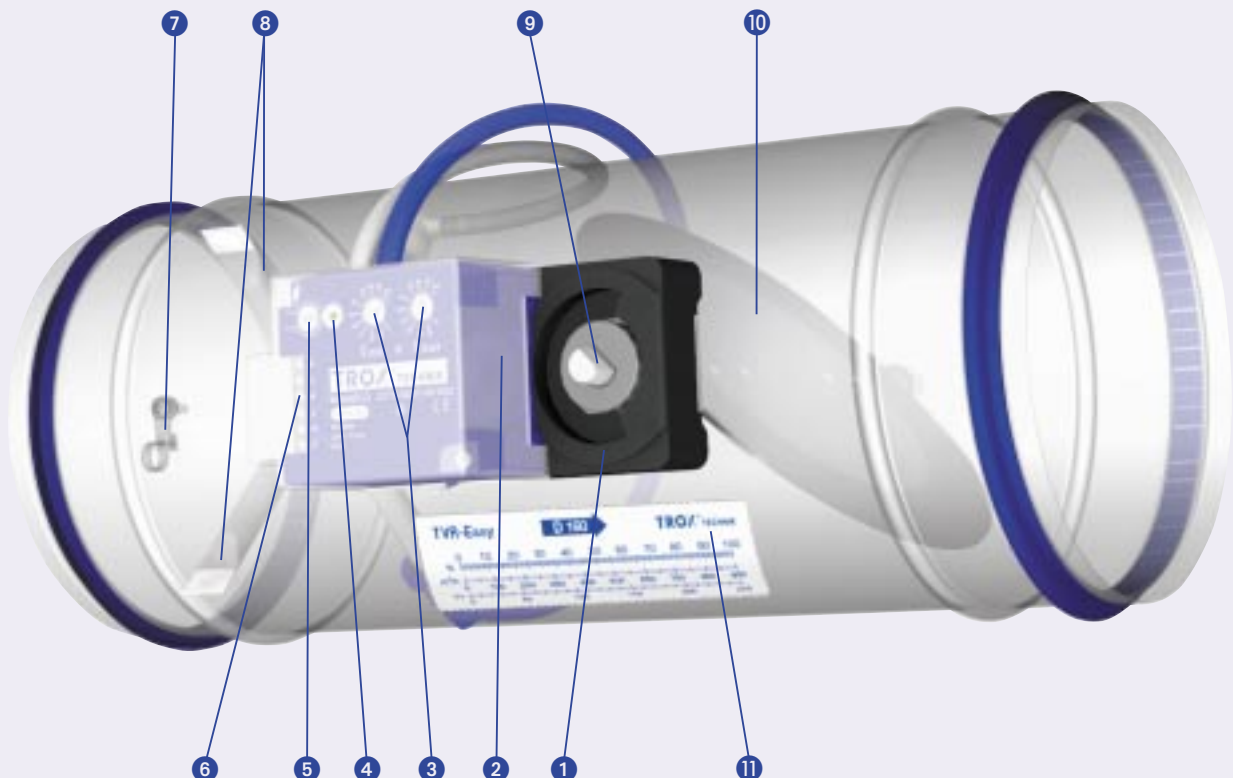

- | | |
|---------------------------|-----------------------------------|
| ① TROX Compact-controller | ⑦ Wire clamping bracket |
| ② Protection cover | ⑧ Differential pressure grid |
| ③ Potentiometers | ⑨ Damper blade position indicator |
| ④ Indicator light | ⑩ Control damper blade |
| ⑤ Service button | ⑪ Flow rate scale |
| ⑥ Connection terminals | |

Construction · Dimensions

Characteristics

- Electronic flow rate control
- Green indicator light provides functional information:
 - permanently on = set
 - blinking = not set
 - off = no supply voltage
- Functional testing as follows:
 - Press service button for at least 1 second
 - Actuator opens damper blade
 - Actuator closes damper blade
 - Actuator returns damper blade to previous position
- High level of control accuracy for the flow rate settings, even if there is an elbow connection $R = 1 D$
- Transparent protection cover to prevent inadvertent resetting and provide general security
- Clamping bracket for wiring
- Differential pressure range 20 to 1000 Pa
- Suitable for non-aggressive air
- Independent of orientation
- Control damper closed blade leakage complies with DIN EN 1751, class 4 (nominal size 100 and 125, class 3)

- For delivery, control damper blade in 45° position
- Spigot connections on both ends suitable for circular connecting ducts to DIN EN 1506 or DIN EN 13180 with groove for lip seal
- Casing air leakage flow rate complies with DIN EN 1751, class A
- The mechanical components are maintenance-free
- Operating temperature range 10 to 50 °C
- Storage temperature range -20 to +80 °C

General information

Standard filtration in air-conditioning systems allows the use of TROX Compact-controllers for the supply air without additional dust protection filters. Since a small volume flow is passed through the transducer in order to measure the flow rate, the following must be noted:

- With heavy dust levels in the room, suitable extract air filters must be provided.
- If the air is contaminated with fluff or sticky particles or contains aggressive media, units should be selected with the on-line design programme "Air terminal units".

TVR-Easy

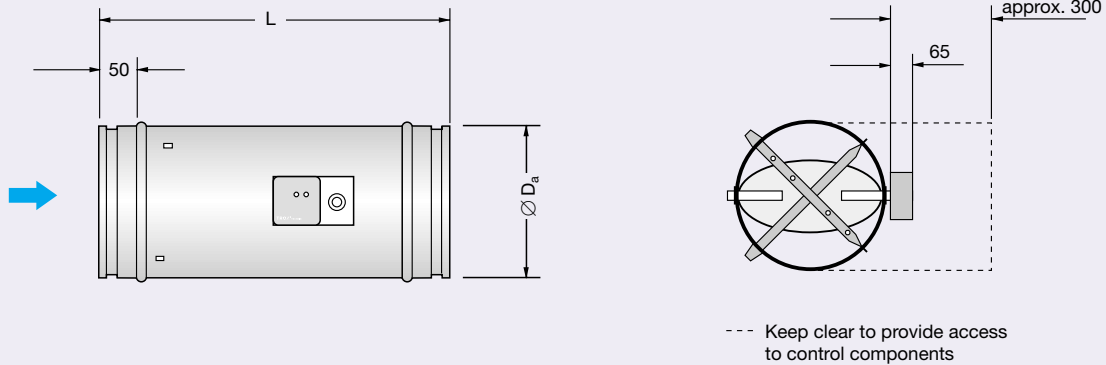

TVRD-Easy

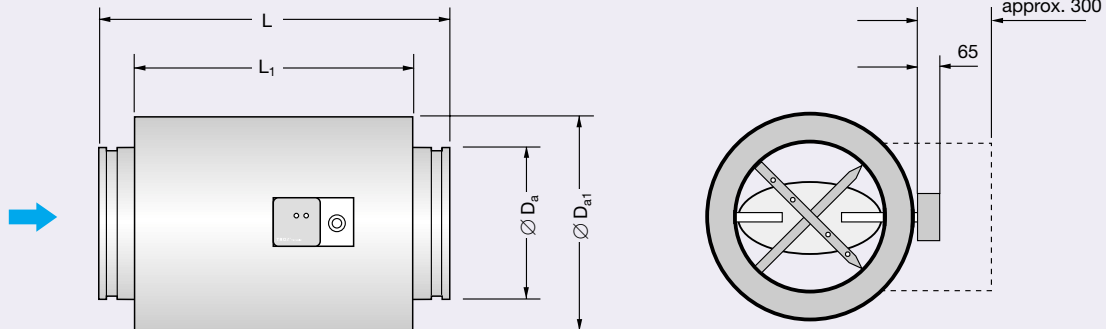

Nominal size	Dimensions in mm				Weight in kg	
	Ø D _a	Ø D _{a1}	L	L ₁	TVR-Easy	TVRD-Easy
100	99	200	310	232	1.4	2.9
125	124	220	310	232	1.7	3.4
160	159	260	400	317	2.2	4.8
200	199	300	400	317	2.6	5.7
250	249	355	400	317	3.3	7.1
315	314	415	500	417	4.8	10.5
400	399	500	500	417	6.1	13.4

TROX Compact-controller technical data

Supply voltage:	24 VAC \pm 20 %, 50/60 Hz or 24 VDC \pm 10 %
Power rating:	max. 5.5 VA (for a.c. voltage) max. 3 W (for d.c. voltage)
Control signal:	0 to 10 VDC, Ri > 100 k Ω
Flow rate actual value signal:	0 to 10 VDC linear, max. 0.5 mA
Transducer range:	2 to 300 Pa
Running time:	120 to 300 sec. for 87°
Torque:	min. 4 Nm, 6 Nm starting torque
Safety class:	III (Save voltage)
Protection level:	min. IP 20



Additional safety requirements for the TROX Compact-controller:

- Installation and assembly must be performed by qualified personnel. Assembly must be carried out in compliance with local legal regulations.
- Connect only to a safety transformer.
- The air terminal units of the TROX-Easy type with TROX Compact-controllers may not be used outside of their standard area of application (air conditioning systems). Use in aircraft is not allowed.

Nomenclature

f_m	in Hz:	Octave band centre frequency
L_W	in dB:	Sound power level of the air-regenerated noise in the room (low pressure) side ducting
L_{W2}	in dB:	Sound power level of the case-radiated noise
L_{W3}	in dB:	Sound power level of the case-radiated noise with additional acoustic cladding
L_{pA}	in dB(A):	A-weighted sound pressure level of air-regenerated noise in the room, system attenuation taken into account
L_{pA1}	in dB(A):	A-weighted sound pressure level of air-regenerated noise in the room with CS circular silencer, system attenuation taken into account
L_{pA2}	in dB(A):	A-weighted sound pressure level of case-radiated noise in the room, system attenuation taken into account
L_{pA3}	in dB(A):	A-weighted sound pressure level of case-radiated noise in the room with additional acoustic cladding, system attenuation taken into account
ΔL_W	in dB:	Correction value for case-radiated noise without additional acoustic cladding
ΔL_{W1}	in dB:	Correction value for case-radiated noise with additional acoustic cladding
\dot{V}_{Nom}	in l/s and m ³ /h:	Nominal flow rate (100 %)
\dot{V}	in l/s and m ³ /h:	Flow rate
$\Delta \dot{V}$	in \pm %:	Flow rate tolerance from setpoint value
$\dot{V}_{min\ unit}$	in l/s and m ³ /h:	Minimum unit flow rate
\dot{V}_{max}	in l/s and m ³ /h:	Maximum flow rate setpoint
\dot{V}_{min}	in l/s and m ³ /h:	Minimum flow rate setpoint
Δp_g	in Pa:	Total pressure differential
$\Delta p_{g\ min}$	in Pa:	Minimum total pressure differential
v	in m/s:	Velocity in the duct system
U	in Volt:	Actual value signal output (0 to 10 VDC)
w	in Volt:	Control signal input (0 to 10 VDC)
$\perp, -$:	Ground, neutral
$\sim, +$:	24 V supply voltage

All sound power levels are based on 1 pW, all sound pressure levels on 20 μ Pa.

All noise levels determined in a reverberation chamber. The sound power data was determined and corrected according to DIN EN ISO 5135, February 1999.

Selection of Nominal Size

The selection of the nominal sizes takes place according to the flow rate range specified by the consultant.

The accurate adjustment of the flow rate setpoints is carried out using a flow rate scale, which is attached on each controller.



		10	20	30	40	50	60	70	80	90	100
	V_{min} %	10	20	30	40	50	60	70	80	90	100
	V_{max} %	10	20	30	40	50	60	70	80	90	100
	Air velocity v in m/s	1.3	2.6	3.9	5.2	6.6	7.9	9.2	10.5	11.9	13.2
	Nominal size										
100	l/s m ³ /h	10 36	20 72	30 108	40 144	50 180	60 216	70 252	80 288	90 324	100 360
125	l/s m ³ /h	15 54	30 108	45 162	60 216	75 270	90 324	105 378	120 432	140 504	155 558
160	l/s m ³ /h	25 90	50 180	75 270	100 360	125 450	150 540	175 630	200 720	225 810	250 900
200	l/s m ³ /h	40 144	80 288	120 432	160 576	200 720	240 864	280 1008	320 1152	365 1314	405 1458
250	l/s m ³ /h	60 216	125 450	185 666	245 882	310 1116	370 1332	430 1548	495 1782	555 1998	615 2214
315	l/s m ³ /h	105 378	205 738	310 1116	410 1476	515 1854	615 2214	720 2592	820 2952	925 3330	1030 3708
400	l/s m ³ /h	170 612	335 1206	505 1818	670 2412	840 3024	1005 3618	1175 4230	1340 4824	1510 5436	1675 6030

Acoustic Quick Selection

System attenuation in dB/Oct. acc. to VDI 2081 (values incorporated into the quick selection table)

f_m in Hz	63	125	250	500	1000	2000	4000	8000
Duct attenuation	0	0	1	2	3	3	3	3
Room attenuation	5	5	5	5	5	5	5	5
End reflection	10	5	2	0	0	0	0	0

Correction for distribution into the duct system (values incorporated into the quick selection table)

\dot{V}	l/s	150	300	450	600	750	900	1200	1500	1800
	m ³ /h	540	1080	1620	2160	2700	3240	4320	5400	6480
dB per octave		0	3	5	6	7	8	9	10	11

Correction for other pressure differentials (averaged values)

Δp_g in Pa	100	200	400	600	800	1000
dB	-5	0	6	9	11	14

Quick selection of sound pressure level in dB(A) with $\Delta p_g = 200$ Pa

Nominal size	\dot{V}		v	$\Delta p_{g \min}$	$\Delta \dot{V}$	L_{pA}	Air-regenerated noise			Case-radiated noise ¹⁾	
							L_{pA1}	L_{pA2}	L_{pA3}		
	l/s	m ³ /h	m/s	Pa	± %	without circular silencer				with circular silencer type CS/CF ²⁾ Length in mm	
100	10	36	1.3	20	15	35	22	12	10	15	6
	40	144	5.2	20	8	47	37	29	27	26	19
	70	252	9.2	35	7	54	45	37	35	33	26
	100	360	13.2	70	5	57	47	38	35	37	29
125	15	54	1.3	20	15	37	24	14	10	17	7
	60	216	5.2	20	7	48	39	33	30	27	19
	105	378	9.2	55	6	52	44	38	36	32	24
	155	558	13.2	90	5	55	45	38	35	36	26
160	25	90	1.3	20	15	42	30	20	16	21	11
	100	360	5.2	25	8	51	42	37	34	30	21
	175	630	9.2	40	7	54	46	41	38	34	25
	250	900	13.2	70	5	56	48	42	40	38	29
200	40	144	1.3	20	15	44	34	25	22	23	8
	160	576	5.2	20	7	50	43	37	36	30	17
	280	1008	9.2	35	5	53	47	43	42	34	23
	405	1458	13.2	65	5	56	48	43	42	39	27
250	60	216	1.3	20	15	41	32	25	23	23	10
	245	882	5.2	20	7	49	43	37	35	35	19
	430	1548	9.2	25	5	50	44	40	39	38	25
	615	2214	13.2	45	5	54	46	41	40	42	30
315	105	378	1.3	20	15	47	39	32	28	31	13
	410	1476	5.2	20	7	50	45	39	37	40	22
	720	2592	9.2	20	6	52	47	41	40	43	29
	1030	3708	13.2	30	5	55	50	44	43	47	35
400	170	612	1.3	20	15	48	41	34	30	33	14
	670	2412	5.2	20	7	49	43	37	35	40	23
	1175	4230	9.2	25	6	49	44	39	37	42	30
	1675	6030	13.2	25	5	52	47	41	40	47	35

1) 4 dB/octave ceiling reduction and 5 dB/octave room attenuation have been allowed for in the calculation of case-radiated noise.

2) See leaflet 6/5/EN/..

Air-regenerated Noise

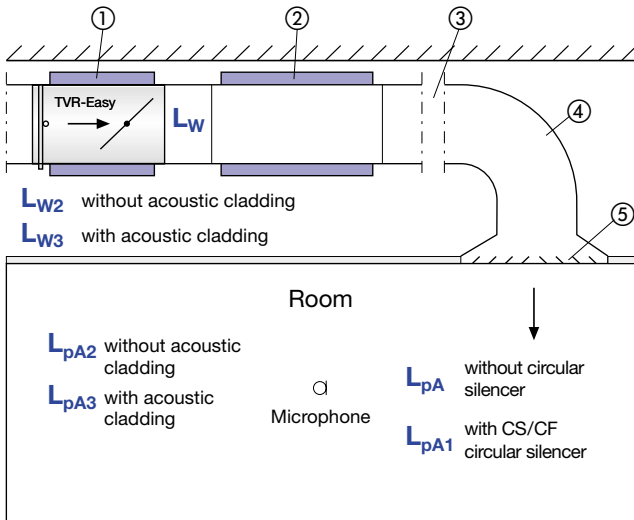

- ① Acoustic cladding
- ② CS/CF circular silencer
- ③ Air distribution to several diffusers
- ④ Duct elbow
- ⑤ End reflection based on diffuser

Nomenclature, see page 5

Air-regenerated noise																											
Nom. size mm	\dot{V}		v	$\Delta p_g = 100 \text{ Pa}$								$\Delta p_g = 200 \text{ Pa}$								$\Delta p_g = 500 \text{ Pa}$							
				L_W in dB								L_W in dB								L_W in dB							
				f_m in Hz								f_m in Hz								f_m in Hz							
				63	125	250	500	1000	2000	4000	8000	63	125	250	500	1000	2000	4000	8000	63	125	250	500	1000	2000	4000	8000
100	10	36	1.3	55	41	40	37	28	17	6	5	55	45	44	42	37	29	20	16	54	48	50	49	45	44	43	35
	40	144	5.2	65	62	54	47	40	34	30	24	66	64	59	52	47	41	36	32	68	66	66	60	56	53	48	45
	70	252	9.2	66	66	61	52	47	44	38	32	70	71	68	58	51	47	43	40	73	75	76	66	61	57	52	51
	100	360	13.2	62	61	62	57	52	50	43	37	71	71	71	61	56	53	48	43	77	79	80	70	63	59	55	54
125	15	54	1.3	43	40	40	39	31	20	10	5	50	42	44	44	40	33	23	18	58	48	48	49	47	47	45	37
	60	216	5.2	61	60	53	47	41	36	30	23	64	65	59	53	47	42	38	33	68	68	67	63	58	56	51	48
	105	378	9.2	62	63	57	50	50	44	39	30	69	70	63	56	53	47	46	39	72	76	74	66	61	57	54	52
	155	558	13.2	64	58	58	54	54	48	43	38	70	68	66	59	57	52	50	45	76	79	79	68	63	59	58	56
160	25	90	1.3	46	44	45	45	39	34	22	16	48	46	46	48	45	40	30	24	55	55	52	54	54	52	49	42
	100	360	5.2	63	61	55	48	45	43	34	28	67	66	61	55	51	50	43	37	70	71	69	64	62	63	56	52
	175	630	9.2	65	64	58	52	51	47	40	34	71	71	65	58	55	53	48	43	77	78	75	68	64	64	59	56
	250	900	13.2	65	65	62	57	57	51	46	40	74	73	69	62	60	57	52	47	82	82	79	71	66	66	61	59
200	40	144	1.3	54	47	45	44	38	34	33	24	50	50	47	49	46	43	42	30	54	51	52	54	56	54	54	44
	160	576	5.2	64	62	52	48	48	47	43	33	68	67	58	53	50	50	50	42	73	71	67	63	59	60	63	55
	280	1008	9.2	66	71	59	55	54	49	44	35	73	75	63	58	56	54	53	45	79	81	72	66	62	63	65	59
	405	1458	13.2	72	70	62	62	60	55	51	45	77	77	68	64	62	59	56	50	83	85	77	70	66	66	67	62
250	60	216	1.3	49	46	41	40	34	27	18	11	49	50	46	48	44	40	32	28	49	54	53	57	58	56	53	45
	245	882	5.2	61	60	51	49	47	51	47	40	65	65	56	53	49	50	52	47	70	71	65	61	57	56	55	58
	430	1548	9.2	65	70	59	56	52	49	44	39	70	73	62	59	54	53	53	47	78	79	71	66	61	60	60	60
	615	2214	13.2	71	68	62	64	59	56	50	45	75	74	68	66	60	58	56	50	82	82	76	71	64	64	63	63
315	105	378	1.3	48	47	44	42	41	40	27	21	52	51	48	50	49	50	39	32	54	53	53	55	61	63	56	48
	410	1476	5.2	64	61	54	51	48	53	50	44	68	66	59	55	52	56	55	48	75	73	67	63	61	66	60	61
	720	2592	9.2	71	70	62	58	54	54	52	46	75	74	66	62	57	58	58	53	81	80	74	68	64	68	63	65
	1030	3708	13.2	75	72	71	65	60	58	53	47	79	76	74	68	62	62	59	55	86	84	80	74	67	70	66	66
400	170	612	1.3	46	46	46	44	44	41	25	18	52	50	49	50	52	51	38	31	56	53	54	57	63	67	57	54
	670	2412	5.2	64	61	54	51	51	47	39	33	70	66	59	56	56	57	52	46	74	71	66	63	64	69	63	65
	1175	4230	9.2	70	69	64	62	54	51	45	40	74	72	66	63	58	58	52	48	81	79	72	68	67	71	65	63
	1675	6030	13.2	78	69	66	67	60	57	52	51	79	74	72	69	63	62	56	56	85	81	77	73	69	73	66	63

Acoustic data for differential pressure up to 1000 Pa, see on-line design programme "Air terminal units".

Case-radiated Noise

Example

Given: $\dot{V}_{max} = 105 \text{ l/s}$ or $378 \text{ m}^3/\text{h}$
 $\Delta p_g = 500 \text{ Pa}$
 Specified sound pressure level in the room 45 dB(A)
 For further assumptions, see calculation procedure

Calculation procedure

Quick selection:

TVR-Easy 125

Air-regenerated noise $L_{pA} = 52 + 8 = 60 \text{ dB(A)}$

Specification is not met, so circular silencer required

TVR-Easy 125 with CF050/125 x 1500

Air-regenerated noise $L_{pA1} = 36 + 8 = 44 \text{ dB(A)}$

Case-radiated noise $L_{pA2} = 32 + 8 = 40 \text{ dB(A)}$

Case-radiated noise calculation procedure

f_m	63	125	250	500	1000	2000	4000	8000
L_W (Page 8)	72	76	74	66	61	57	54	52
ΔL_W	30	29	26	21	18	12	12	10
L_{W2}	42	47	48	45	43	45	42	42
Ceiling reduction	4	4	4	4	4	4	4	4
Room attenuation	6	6	5	5	5	4	4	4
A-weighting	-26	-16	-9	-3	0	1	1	-1
Corrected level	6	21	30	33	34	38	35	33

Result: $L_{pA2} = 42 \text{ dB(A)}$

Specification is met.

Correction values for case-radiated noise

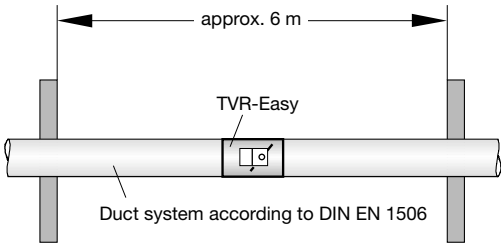
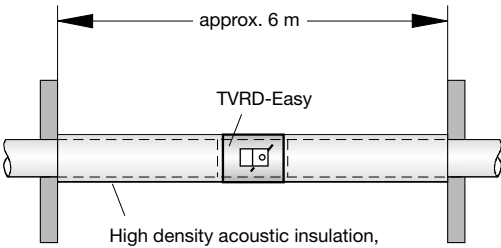
Installation configuration	$\Delta L_W / \Delta L_{W1}$	Nom. size	$\Delta L_W / \Delta L_{W1}$ in dB, base on f_m in Hz							
			63	125	250	500	1000	2000	4000	8000
TVR-Easy $L_{W2} = L_W - \Delta L_W$  Duct system according to DIN EN 1506	ΔL_W	100	31	30	27	21	19	11	11	9
		125	30	29	26	21	18	12	12	10
		160	30	29	24	21	19	16	14	12
		200	29	28	23	22	21	18	16	13
		250	25	25	20	18	16	14	12	11
		315	22	22	19	17	15	13	11	10
		400	20	19	18	17	15	12	10	10
TVRD-Easy (with acoustic cladding) $L_{W3} = L_W - \Delta L_{W1}$  High density acoustic insulation, supplied by others	ΔL_{W1}	100	33	28	26	26	34	33	37	31
		125	32	29	25	27	33	33	37	32
		160	32	32	24	28	34	38	40	34
		200	31	31	26	33	39	44	43	35
		250	27	28	23	29	35	42	36	31
		315	24	25	23	29	34	41	35	29
		400	22	23	22	29	35	39	33	29

Flow Rate Adjustment

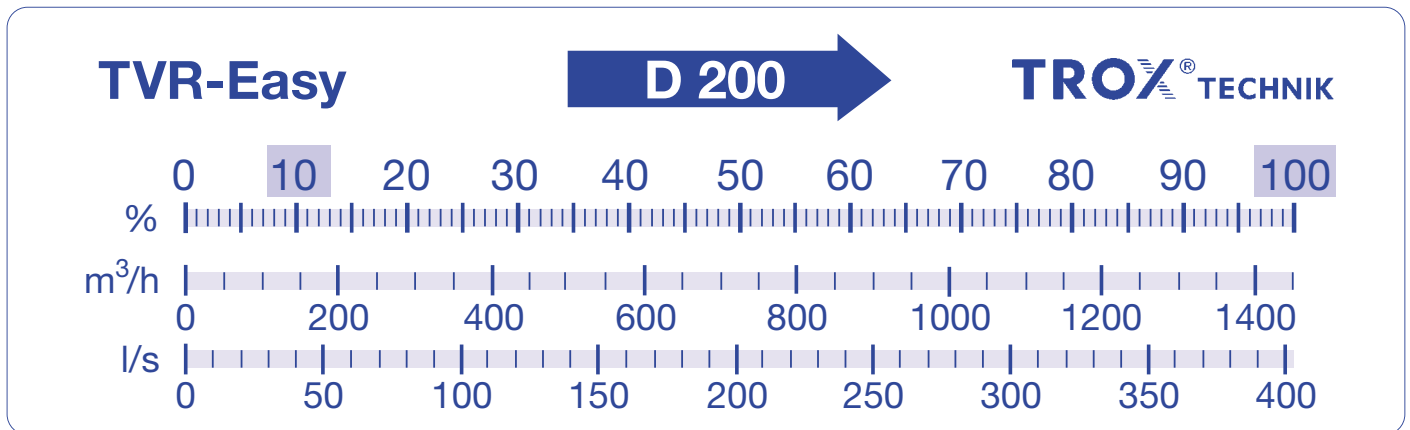

On each TVR Easy, a flow rate scale is available in order to determine the settings on site (see example nominal size 200 above).

Variable flow rate control

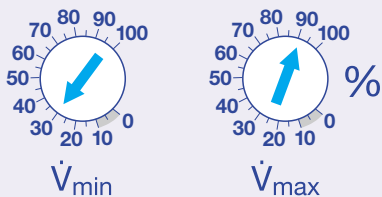

The required flow rates must be adjusted by the customer. If \dot{V}_{\min} is set higher than \dot{V}_{\max} , then \dot{V}_{\min} is provided as a constant flow rate, even if a control signal is transmitted.

If \dot{V}_{\min} is set on 0 %, then control is between shut-off and \dot{V}_{\max} . If the control signal falls below 0.1 VDC, the control damper closes (leakage flow only).

Constant flow rate control

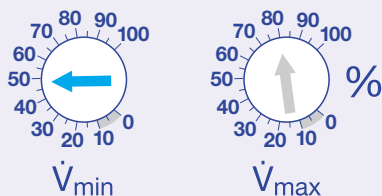

The constant flow rate can be set with the \dot{V}_{\min} -potentiometer. The setting of the \dot{V}_{\max} -potentiometer is unimportant.

BMS operation

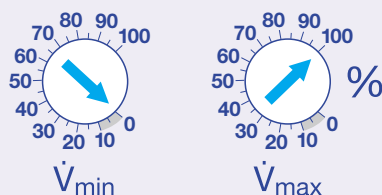

If the flow rate is set by the BMS, the \dot{V}_{\min} -potentiometer must be set at 0 % and the \dot{V}_{\max} -potentiometer must be set at 100 %. If the control signal falls below 0.1 VDC, the control damper closes (leakage flow only).

Factory setting

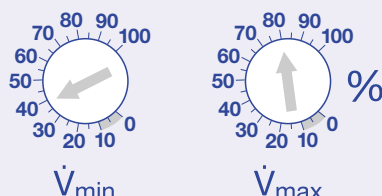

For delivery, settings are, $\dot{V}_{\min} = 40\%$ and $\dot{V}_{\max} = 80\%$.

Characteristics · Wiring Examples

Characteristics of the control signal (Example)

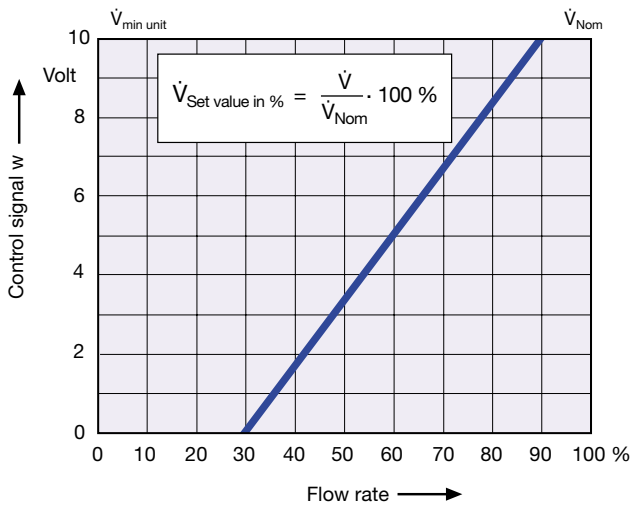

Characteristic of actual value signal

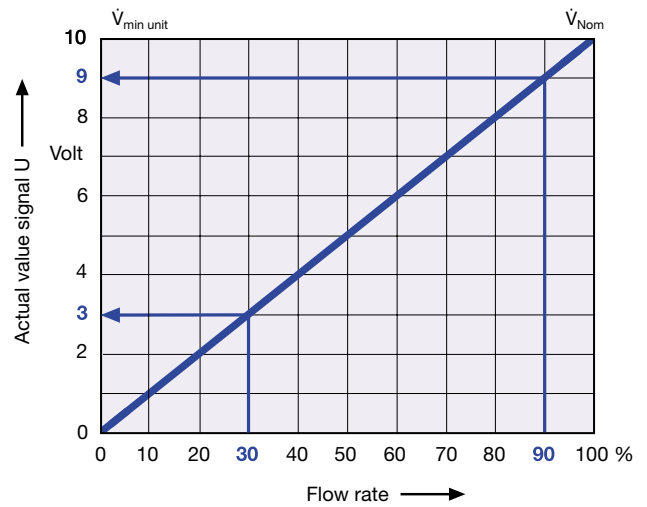

Variable flow rate control

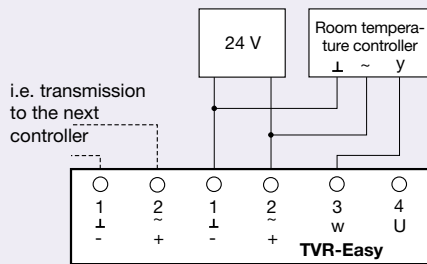

The connection of supply voltage and of the remote room temperature controller must be carried out as shown in the circuit diagram opposite.

Constant flow rate control

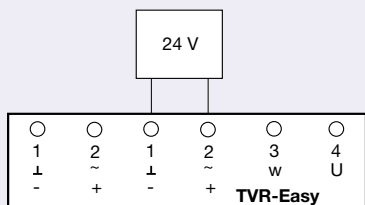

As soon as the 24 V supply voltage is applied, the controller runs the set \dot{V}_{min} -value as a constant flow rate.

$\dot{V}_{\text{min}} / \dot{V}_{\text{max}}$ changeover

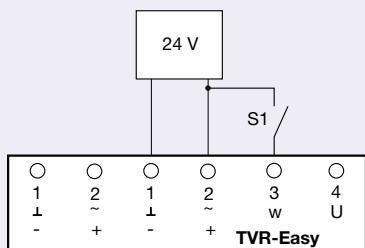

The switch S1 enables a changeover between the two constant flow rates of \dot{V}_{min} and \dot{V}_{max} .

Switch S1 open : \dot{V}_{min}
Switch S1 closed : \dot{V}_{max}

When there is parallel connection of multiple TVR-Easy controllers, the switch S1 must be used as changeover switch and the contact for the \dot{V}_{min} operation must be connected to the ground (terminal 1).

Override controls OPEN / CLOSED

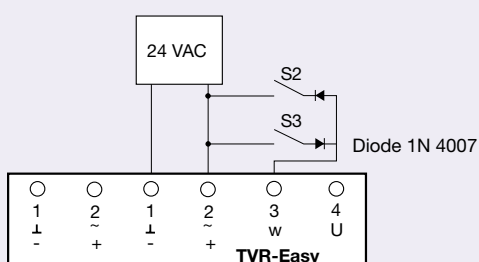

The override controls to provide OPEN and CLOSED can be achieved using external switches (potential-free contacts), only for a.c. voltage.

Switch S2 closed: Damper blade CLOSED
Switch S3 closed: Damper blade OPEN

All override controls can be combined among themselves and with the different circuit options.

The customer made connections and wiring must comply with the local standards for electrical wiring!

Order Details

Specification text

Make: TROX. VAV circular controller Type TVR-Easy for variable air volume flow systems, for supply air or extract air, in 7 nominal sizes.

Selection based on nominal size determination. Simple setting by the customers of the volume flow with \dot{V}_{\min} - and \dot{V}_{\max} -adjustment potentiometers with percentage scales. During the installation or commissioning of controller, adjustment is possible without supply voltage. A transparent protection cover prevents inadvertent resetting and provides general security. Control damper blade delivery is in 45° position in order to allow ventilation air flow without additional control functions.

Special characteristics:

- Flow rate adjustment without adjustment tool
- Functional testing with service button
- Functional check by indicator light
- Factory functional testing of each unit using a dedicated test rig

High visibility external indicator light for signalling the functions:

Set, not set and power failure.

Functional testing of actuator 'CLOSED/OPEN and control operation' possible with service button.

Electrical connections with screw terminals, terminal for looping the 24 V supply voltage, i.e. for the connection of simple voltage transmission to the next controller.

Wire clamping bracket fixed to the casing.

Voltage range for control and actual value signal 0 to 10 VDC. Possible override controls with external switches using potential-free contacts: CLOSED, OPEN, \dot{V}_{\min} or \dot{V}_{\max} .

Integral differential pressure sensor with 3 mm measurement holes which are, to a large extent resistant to contamination. Damper blade closed leakage to DIN EN 1751, class 4 (nominal sizes 100 and 125, class 3). Position of the damper blade visible externally based on the milled flat on the shaft extension. TROX Compact electronic flow rate controller factory fitted. Casing air leakage complies with DIN EN 1751, class A. Differential pressure range 20 to 1000 Pa.

Materials:

Casing in galvanised sheet steel, aluminium sensor tubes, thermoplastic elastomer control damper blade seal and plain bearings.

Unit variant with:

Additional acoustic cladding to reduce case-radiated noise. Consists of 50 mm mineral wool and outer cover of galvanised sheet steel. This gives a reduction in case-radiated noise of minimum 7 dB providing the upstream and downstream ducting has a rigid external insulation. Non-retrofitable.

Order code

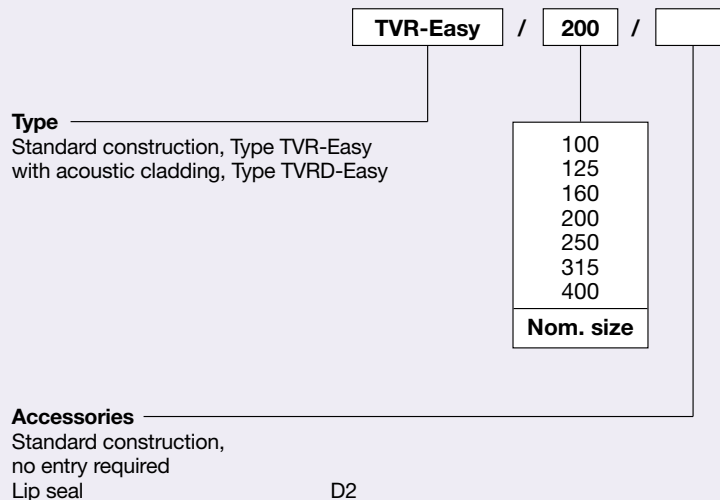

Order example

Make: TROX
Type: TVR-Easy / 200